



## SPI-336-99-T1

### Ultraminiature photoreflector supporting reflow soldering (Single transistor type)

#### Features

- Infrared LED plus Phototransistor (single)
- DIP type
- Compact type : 3.4 (L) × 2.7 (W) × 1.5 (H) mm
- Visible light cut type
- Taping type

#### Absolute Maximum Ratings at Ta=25°C, 65%RH (as per JIS C7032)

Parameter		Symbol	Rating	Unit
Input LED	Forward Current	I <sub>F</sub>	50	mA
	Reverse Voltage	V <sub>R</sub>	5	V
	Power Dissipation	P <sub>D</sub>	70	mW
Output Phototransistor	Collector-Emitter Voltage	V <sub>CEO</sub>	20	V
	Emitter-Collector Voltage	V <sub>ECO</sub>	5	V
	Collector Current	I <sub>C</sub>	20	mA
	Power Dissipation	P <sub>C</sub>	70	mW
Operating Temperature		T <sub>opr</sub>	-20 to +80	°C
Storage Temperature		T <sub>stg</sub>	-30 to +100	°C

#### Electro-Optical Characteristics at Ta=25°C, 65%RH

Parameter		Symbol	Condition	Min.	Typ.	Max.	Unit
Input	Forward Voltage	V <sub>F</sub>	I <sub>F</sub> =10mA	1.0	1.2	1.6	V
	Reverse Current	I <sub>R</sub>	V <sub>R</sub> =5V	-	-	10	μA
Output	Dark Current	I <sub>CEO</sub>	I <sub>F</sub> =0mA, V <sub>CE</sub> =10V	-	-	200	nA
Coupled	Collector Output	I <sub>C</sub>	I <sub>F</sub> =10mA, V <sub>CE</sub> =5V *1	80	-	1100	μA
	Leakage Current	I <sub>LEAK</sub>	I <sub>F</sub> =10mA, V <sub>CE</sub> =5V *2	-	-	1	μA
	Collector Emitter	V <sub>CE(sat)</sub>	I <sub>F</sub> =10mA, I <sub>C</sub> =50μA	-	-	0.5	V
	Rise Time	t <sub>r</sub>	V <sub>CC</sub> =5V, R <sub>L</sub> =100Ω	-	5	-	μs
	Fall Time	t <sub>f</sub>	I <sub>C</sub> =1mA	-	5	-	μs

\*1 Location of reflector is shown in Fig. 1.



Fig. 1 Location of Reflector

\*2 No reflector

\*3 Table of Classification of Collector Output

Class	A	B	C	D
I <sub>C</sub> (μA)	1100 to 450	600 to 260	350 to 150	200 to 80

Typical Characteristics



These numerical value show the electrical and optical characteristics of this product, and not assure this contents.

Forward Current vs. Ambient Temperature

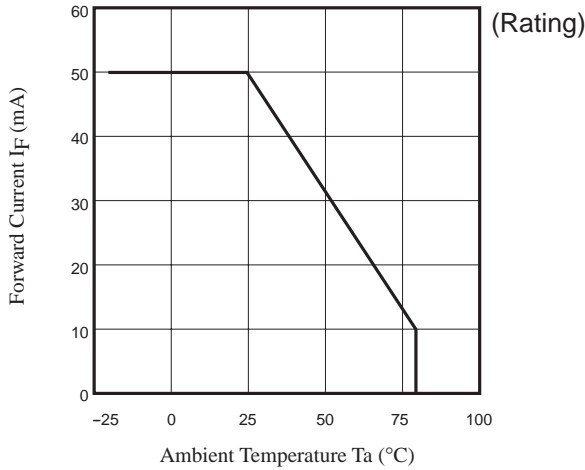

Power Dissipation vs. Ambient Temperature

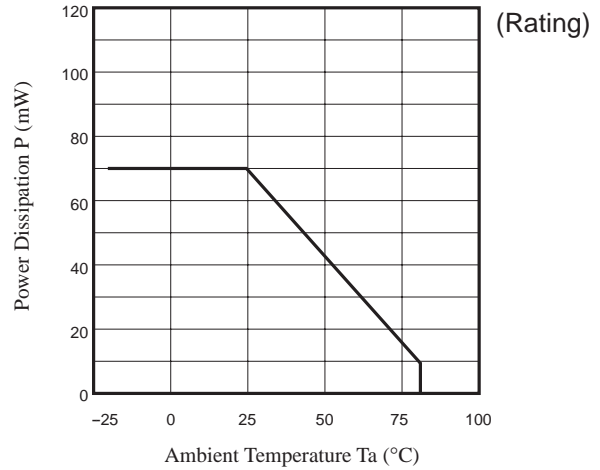

Forward Current vs. Forward Voltage

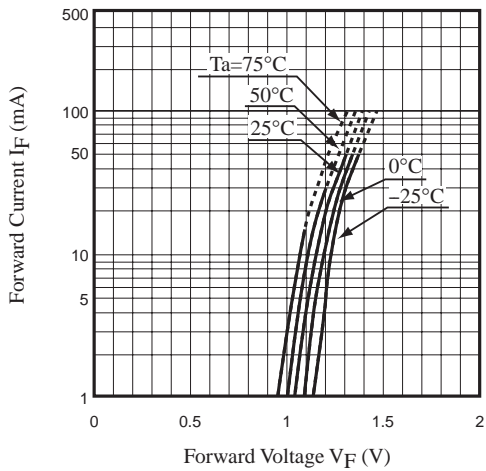

Collector vs. Forward Current

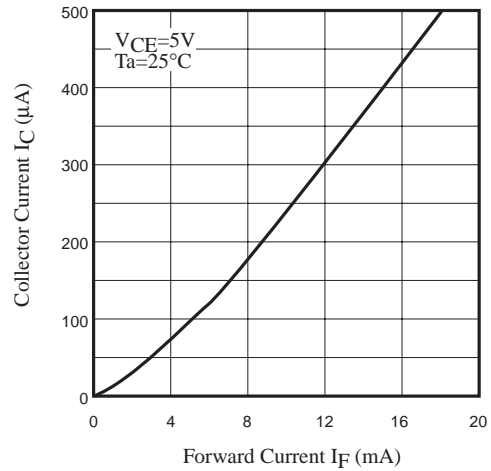

Collector Current vs. Collector-emitter Voltage

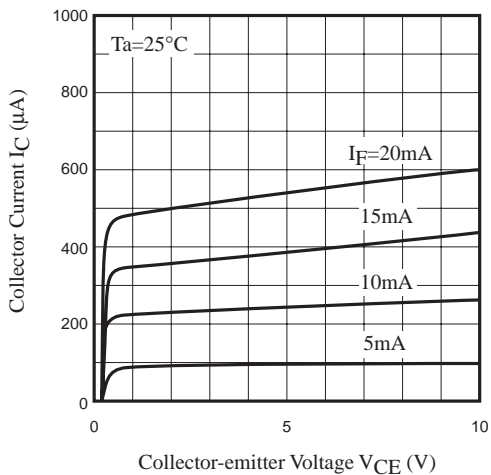

Relative Collector Current vs. Ambient Temperature

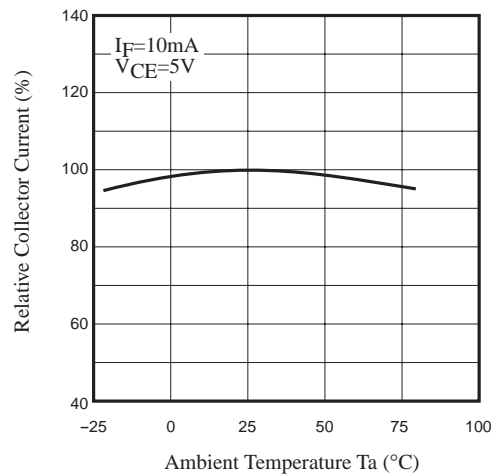

Typical Characteristics



These numerical value show the electrical and optical characteristics of this product, and not assure this contents.

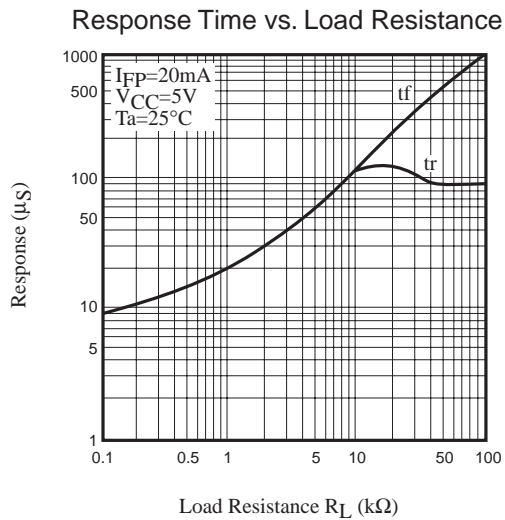
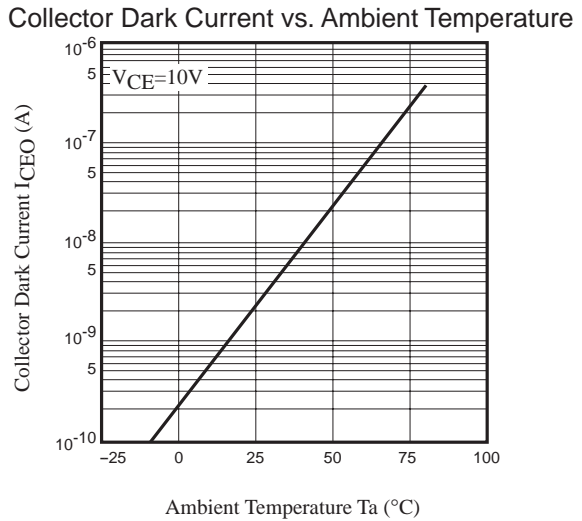
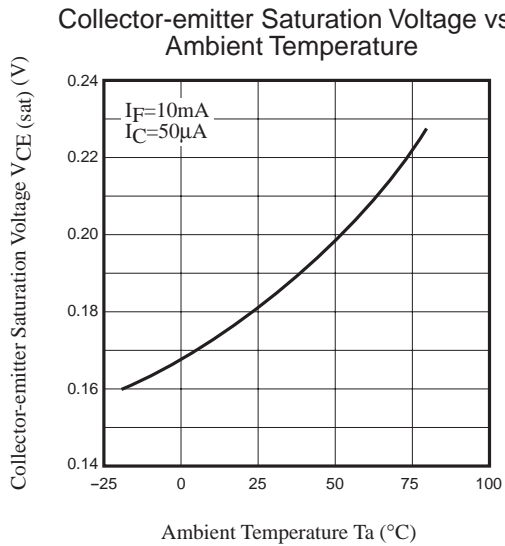

Test Circuit for Response Time

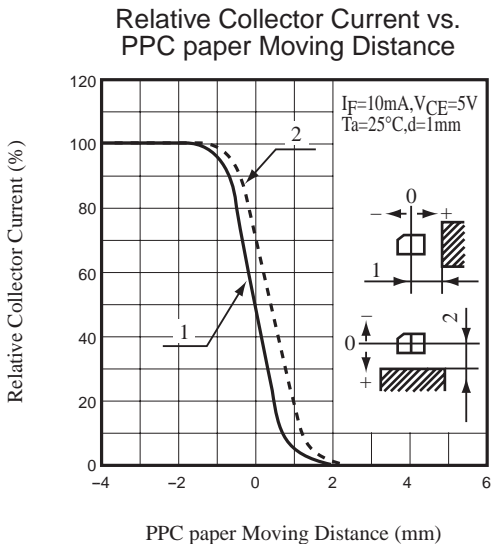
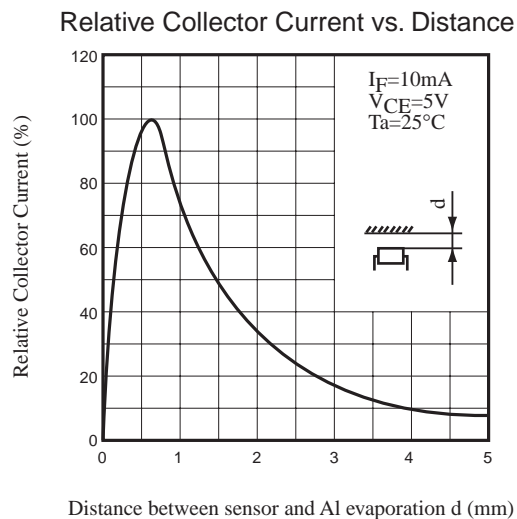
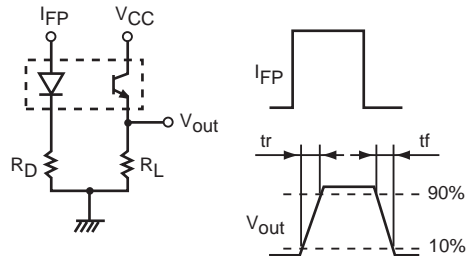

# SPI-336-99-T1

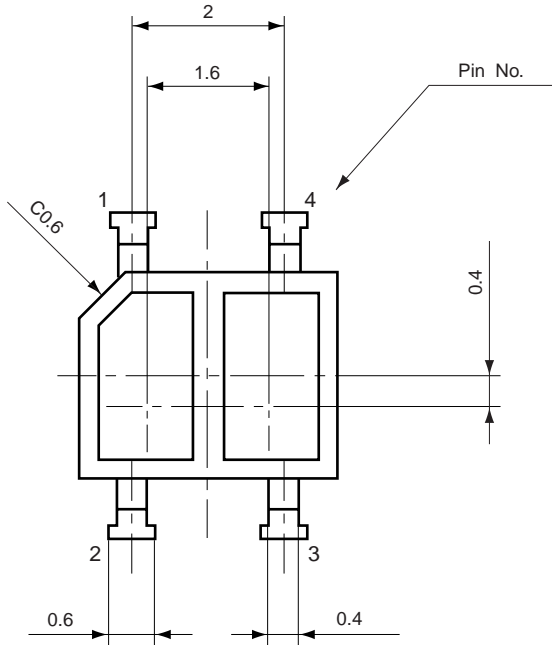

- Pin connection
1. LED Anode
  2. LED Cathode
  3. Ph. Tr Collector
  4. Ph. Tr Emitter

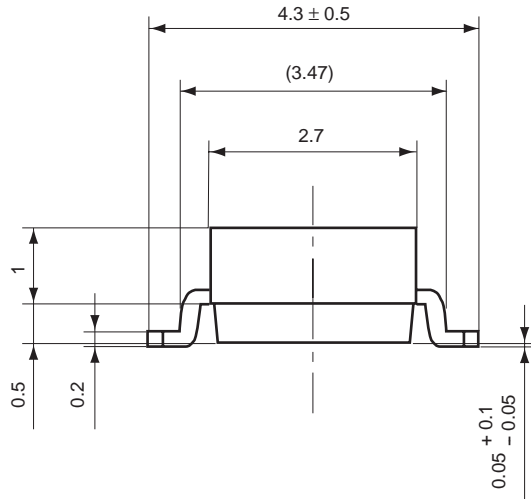
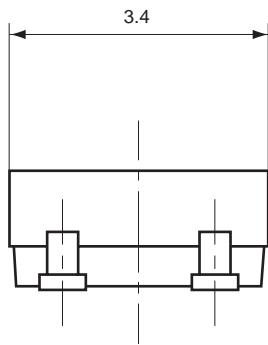

Tolerance :  $\pm 0.2$   
Unit : mm

**Package dimensions and Pin connection**

As stated in the sttached paper. (No.6030 4/6)

**Soldering conditions**

(1) Reflow soldering

The temperature of the reflow furnace is to be set in accordance with the following temperature profile.

Soldering must be done only two time.

- Temperature : On the topsurface of product
- Reflow type : Hot air

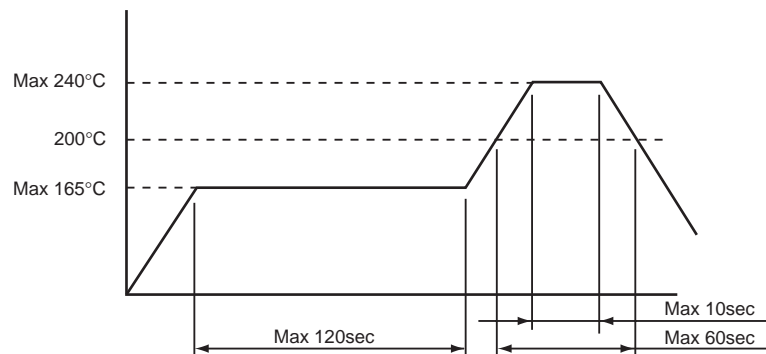

(2) Manuasl soldering

- Temperature : Max. 290°C (Soldering iron tip temperature)
- Time : Max. 3 sec
- Clearance : Min. 0.5mm from package

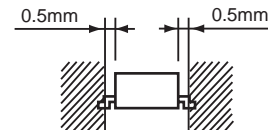

**▲ PRECAUTIONS**

- (1) Bending a lead should avoid. However, when bending is necessary, take care the next items.
  - ① Bending a lead must be done before soldering.
  - ② Bending a lead must be done in the states of fixing leads and no stress for the regin part. Because it is possible that stress for the regin part cause troubles such as gold wire breaking and so on.
  - ③ A lead must be bend at intervals of 0.5mm from the case edge.
  - ④ Do not bend the same position of leads more than twice.
- (2) The hole pitch of a circuit board must fit to the lead pitch.
- (3) Take core the following when soldering.
  - ① Do not heat a product under any stress (a twist and so on) to leads.
  - ② Do not heat a product in the states of operating force to the regin part.
- (4) Use the flux which contain no chlorine, have no corrosion and do not need washing.
- (5) Be careful that flux or other chemicals do not attach to the luminous surface and passive surface.
- (6) Precautions of the product after the open dry packing
  - ① The product after the open dry packing should be stored in the dry packing again.  
 The product should be kept under the conditions below, if the product is not stored in the dry paking.
    - Temperature : 5 to 30°C
    - Humidity : Max 70%RH
    - Term : Max 7days
  - ② The product to be out the term without dry packing must be practiced baking.  
 Baking conditions : +60±5°C, 10 to 20Hr
- (7) The reflow conditions must be confirmed that no problem by your reflow furnace.

 **CAUTION**

1. No products described or contained herein are intended for use in surgical implants, life-support systems, aerospace equipment, nuclear power control systems, vehicles, disaster / crime-prevention equipment or the like, and the failure of which may directly or indirectly cause injury, death or property loss.
2. Anyone purchasing any products described or contained herein for an above-mentioned use shall:
  - 1) Accept full responsibility and indemnify and defend SANYO ELECTRIC CO.,LTD., it's affiliates, subsidiaries and distributors or any of their officers and employees, jointly and severally, against any and all claims and litigation and all damages, costs and expenses associated with such use.
  - 2) Not impose any responsibility for any fault or negligence which may be cited in any such claim or litigation on SANYO ELECTRIC CO., LTD., it's affiliates, subsidiaries and distributors or any of their officers and employees jointly or severally.
3. Information (including circuit diagrams and circuit parameters) disclosed herein is for example only; it is not guaranteed for mass production, SANYO believes the information disclosed herein is accurate and reliable, but no guarantees are made or implied regarding it's use or any infringements of intellectual property rights or other rights of third parties.

## Precautionary instructions in handling gallium arsenic products

Special precautions must be taken in handling this product because it contains, gallium arsenic, which is designated as a toxic substance by law. Be sure to adhere strictly to all applicable laws and regulations enacted for this substance, particularly when it comes to disposal.

Manufactured by ; **Tottori SANYO Electric Co., Ltd.**  
LED Division  
5-318, Tachikawa-cho, Tottori City, 680-8634 Japan  
TEL: +81-857-21-2137 FAX: +81-857-21-2161